

-Features:

Hold open at 90° and 140°~ 120°(optional)

- Keep the gaps as per drawing, make sure the top and bottom pivot center are well aligned.

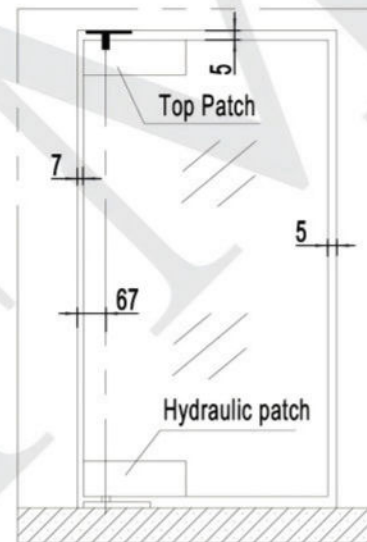
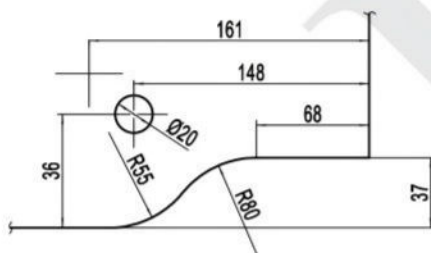
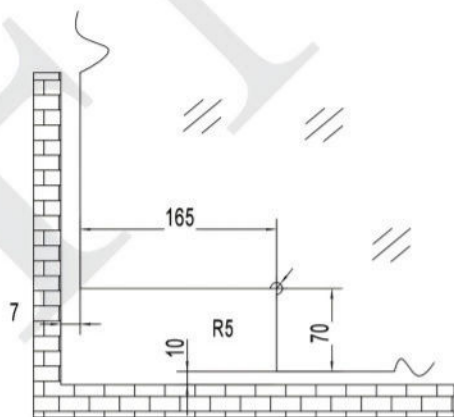

Model	Max. door width (mm)	Max. door weight (kg)	Glass Thickness	Application of rubber gasket
				Thickness (1.5mm)
HYP-101	≤ 914.4	80	10-12	4
			14-15	2

NOTES:

- PROPRIETARY AND CONFIDENTIAL
 - THE INFORMATION CONTAINED IN THIS DRAWING IS THE SOLE PROPERTY OF FMF GLASS HARDWARE. ANY REPRODUCTION IN PART OR AS A WHOLE WITHOUT THE WRITTEN PERMISSION OF FMF GLASS HARDWARE IS PROHIBITED.

PRODUCT NAME:

Hydraulic Hinge- 100kg

PRODUCT MODEL NUMBER:

HYP-101

DWG NO.

HYP-101

UNIT:

MM

DWG SIZE/SCALE

A4/NTS

FMF GLASS HARDWARE

REV.

1

DATE: 01.22

DRAWN BY: FMF

SHEET 1 OF 1

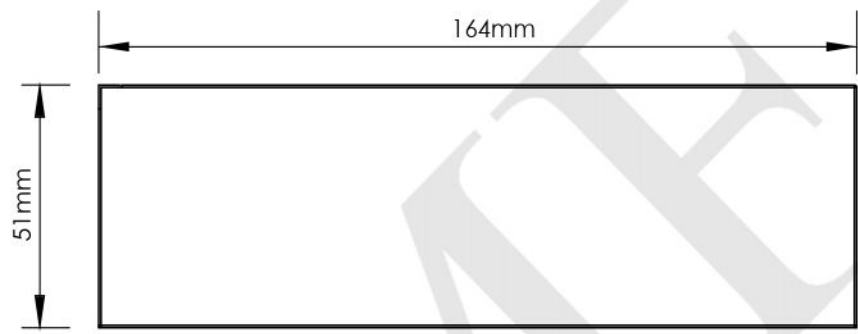

ELEVATION

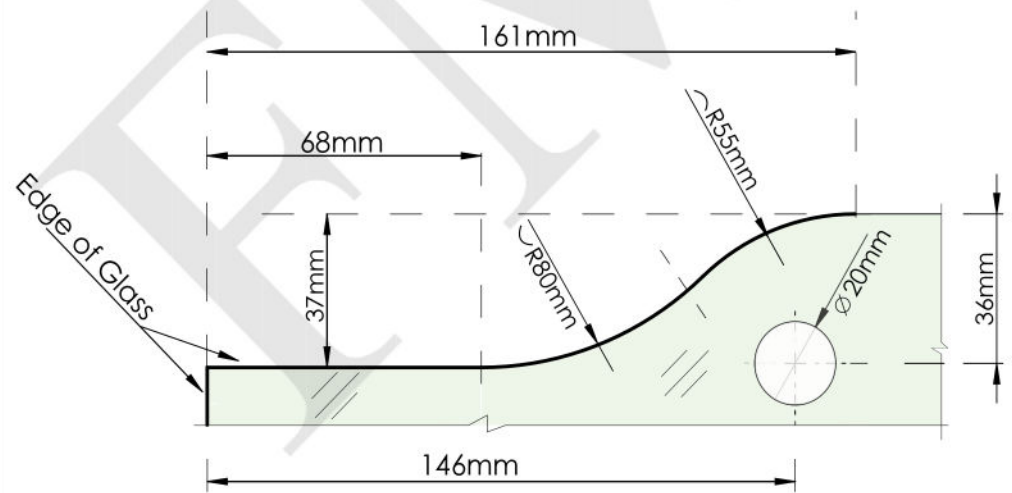

GLASS FABRICATION

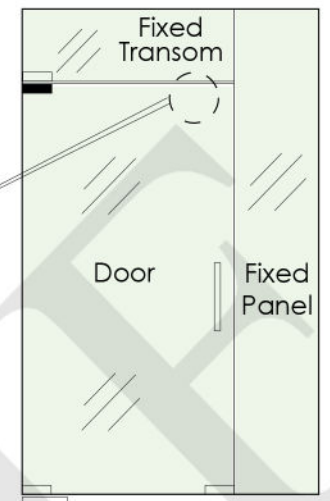
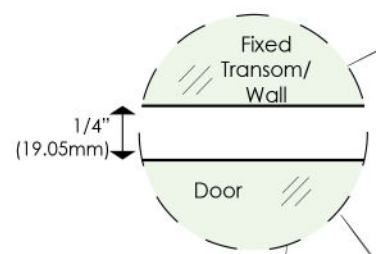

PAT-02

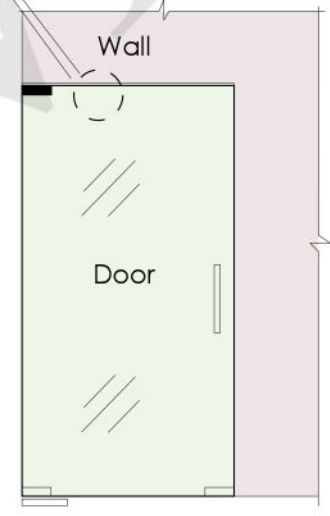
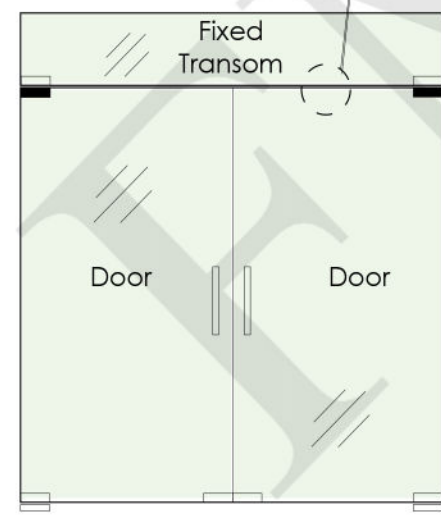

NOTES:
 - PROPRIETARY AND CONFIDENTIAL
 - THE INFORMATION CONTAINED IN THIS DRAWING IS THE SOLE PROPERTY OF FMF GLASS HARDWARE. ANY REPRODUCTION IN PART OR AS A WHOLE WITHOUT THE WRITTEN PERMISSION OF FMF GLASS HARDWARE IS PROHIBITED.

PRODUCT NAME:
Patch fitting ceiling pivot

PRODUCT MODEL NUMBER:
PAT-02

DWG NO.
PAT-02_1
 DATE:
01.22

UNIT:
MM
 DRAWN BY:
FMF

DWG SIZE/SCALE
A4/NTS

FMF GLASS HARDWARE

REV. **1**
 SHEET **1** OF **1**